

# LUMATECH

## Linear Lighting Solutions

### LT100D Direct Suspended

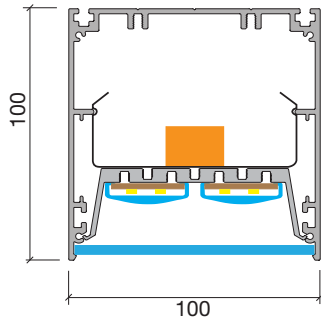
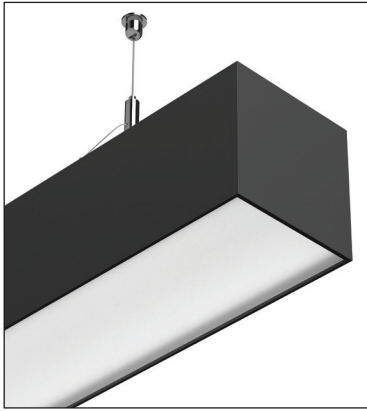

#### DISTRIBUTION

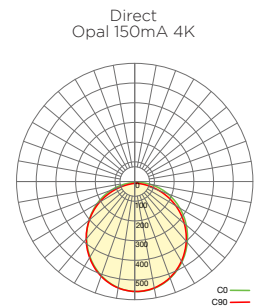
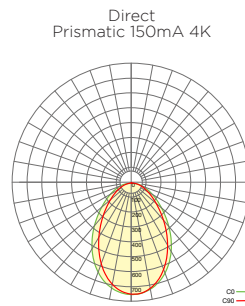
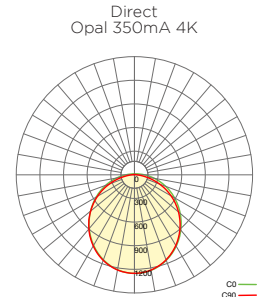
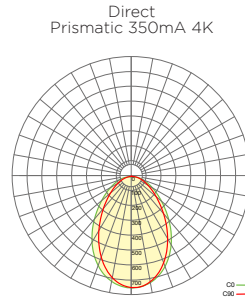

#### FEATURES

- Designed with the installer in mind for a fast & cost effective install.
  - A substantial gear tray provides excellent thermal management ensuring long component life and high lumen maintenance.
  - Choice of screwed or screwless endcaps.
  - High efficacy up to 125Lm/W.
  - Plug & play joining of long runs over 5m.
  - Tridonic LED boards & drivers (3K & 4K a standard).
  - Colour consistency 3 MacAdams.
  - L90 @ 50,000hrs B10 & CRI 90 as standard.
  - Certified IES files.
  - Designed & manufactured locally.
  - Where possible components are sourced locally.
  - The 6060 grade aluminium used in the production of these profiles is smelted and extruded in New Zealand.
- The CO2 emitted per Kg of aluminium produced is one of the lowest in the world.

#### CONTROL - DIM - EMERGENCY

Bluetooth 	Wireless 	Proximity 	Emergency 
DALI Dimming 	DSI Dimming 	Switch Dim 	Corridor Function 

**CASAMBI**

#### DIFFUSERS

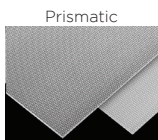

- High Transmission
- Opalescent Appearance
- No pixellation
- Low UGR
- Soft Edge Beam for Uniformity

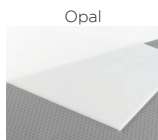

- High Transmission
- Homogeneous
- No pixellation
- Maintains High CRI
- High Vertical Illuminance



- Geartray Lens
- 97% Transmission
- 90deg Distribution
- Focuses Output On Diffuser
- Can Be Used Stand Alone

#### COLOURS

- Powder Coat Colours
- Dulux Mannex White
  - Dulux Mannex Black
  - Dulux Mannex Silver Pearl (Light Grey)
  - Custom colours to order

Cast sheet is chosen for diffusers due its greater dimensional stability. Linear lens are PMMA from Tridonic and provide touch protection for non SELV applications.

**5**  
YEAR

# LUMATECH

## Linear Lighting Solutions

### LUMEN/M

	CRI90 p/m 4000K	150mA		200mA		250mA		300mA		350mA		400mA	
		Lm	W	Lm	W	Lm	W	Lm	W	Lm	W	Lm	W
LT100D 2xLow Output	Opal	1412	12.6	2025	16.5	2262	20.7	2649	25.2	3073	29.8	3524	34.0
	Micro Prismatic	1308		1702		2096		2454		2848		3264	
LT100D 2xMed Output	Opal	2147	18.9	3079	24.8	3438	31.1	4027	37.8	4671	44.7	5356	51.0
	Micro Prismatic	1989		2587		3186		3730		4328		4962	
LT100D 2xHigh Output	Opal	3263	28.4	4680	37.1	5225	46.6	6121	56.7	7101	67.1	N/A	
	Micro Prismatic	3023		3932		4842		5669		6579			

### JOINS & CORNERS

Profile corners and joins are welded providing a seamless transitions and no light leakage.

Custom angled joins on request.

Joins can be horizontal or vertical

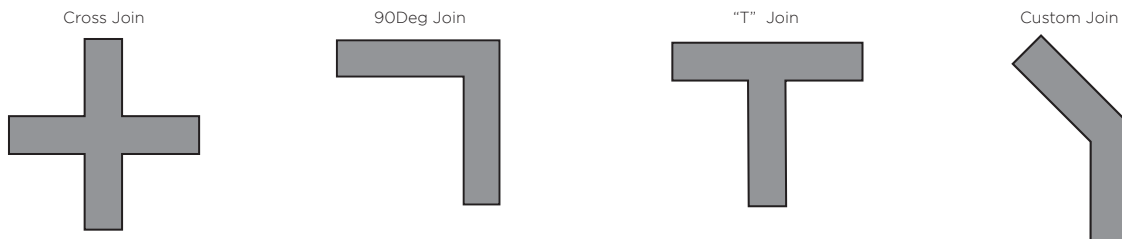

### LENGTH CALCULATION

Luminaires are constructed using a combination of gear tray module sizes

Module lengths start from 565mm and increase by 140mm increments to achieve the required length

Endcap assembly requires a 10mm allowance and for recessed luminaires. This dimension becomes the cut-out dimension

For specified lengths that fall between the 140mm increments powder coated blanking plates can be added to avoid any unlit diffuser sections.

Gear Tray Options: 565mm, 705mm, 845mm, 945mm, 1125mm, 1265mm, 1405mm, 1545mm & 1685mm

Length Example 1: 2400mm required length >> 1125mm Geartray + 1265mm Geartray = 2390mm

Plus 10mm for pair of endcaps = 2400mm

Length Example 2: 5100mm required length >> 1685mm Geartray x 3 = 5055mm

plus 10mm for pair of endcaps = 5065mm

### ACCESSORIES & OPTIONS

- Italian 3m & 5m suspensions with tool-less height adjustment.
- Screwed Endcaps for budget applications.
- Screwless endcaps for a seamless look.
- Round or square ceiling roses.
- Rod suspensions.

Lumatech Limited, 5/152 Lansford Crescent, Avondale,  
Auckland, New Zealand.

Ph: 09-2813732 Email: sales@lumatech.co.nz www.lumatech.co.nz