

LUMATECH

Linear Lighting Solutions

LT60H Wall Bracket Mount Direct-Indirect Batwing

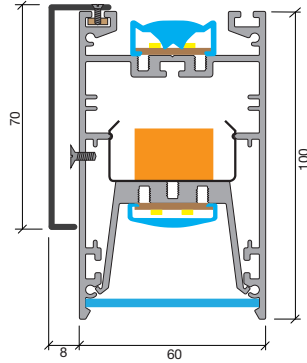
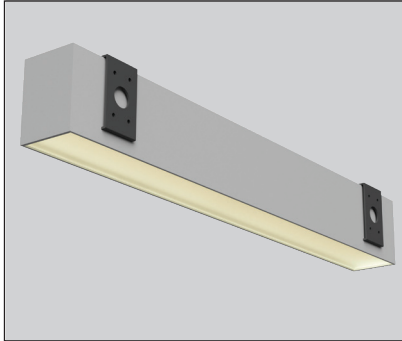

FEATURES

- Designed with the installer in mind for a fast & cost effective install.
- A substantial gear tray provides excellent thermal management ensuring long component life and high lumen maintenance.
- Choice of screwed or screwless endcaps.
- High efficacy up to 125Lm/W.
- Plug & play joining of long runs over 5m.
- Tridonic LED boards & drivers (3K & 4K as standard) with 2.7K, 5K, 6.5K, Tuneable White 27-65K options & Sunlike full spectrum.
- Colour consistency 3 MacAdams.
- L90 @ 50,000hrs B10 & CRI 90 as standard.
- Certified IES files.
- Designed & manufactured locally.
- Where possible components are sourced locally.
- The 6060 grade aluminium used in the production of these profiles is smelted and extruded in New Zealand. The CO2 emitted per Kg of aluminium produced is one of the lowest in the world.
- The indirect component uses a Tridonic batwing distribution linear lens for even upward illumination.
- Direct/indirect commonly switched has a 67/33 lumen split as standard a with 50/50 lumen split for individually switched.

DIFFUSERS

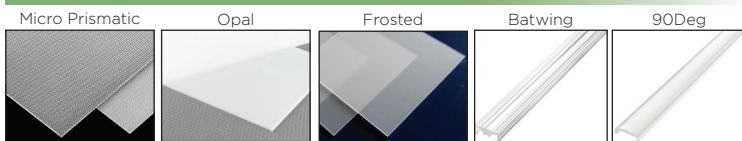

- | | | | | |
|--|---|---|--|--|
| <ul style="list-style-type: none"> • High Transmission • Opalescent Appearance • No pixellation • Low UGR • Soft Edge Beam for Uniformity | <ul style="list-style-type: none"> • High Transmission • Homogeneous • No pixellation • Maintains High CRI • High Vertical Illuminance | <ul style="list-style-type: none"> • 92% Transmission • Homogeneous • Maintains High CRI | <ul style="list-style-type: none"> • 95% Transmission • Batwing Symmetric Distribution • Smooth Wide Wash | <ul style="list-style-type: none"> • Geartray Lens • 97% Transmission • 90deg Distribution • Focuses Output On Diffuser • Can Be Used Stand Alone |
|--|---|---|--|--|
-
- | |
|---|
| <p>Asymmetric</p>  <ul style="list-style-type: none"> • 95% Transmission • Single Asymmetric • Suitable For Wall Up Light • Can Be Used Stand Alone |
|---|

Cast sheet is chosen for diffusers due its greater dimensional stability. Linear lens are PMMA from Tridonic and provide touch protection for non SELV applications.

DISTRIBUTION

Batwing Indirect
Opal Direct

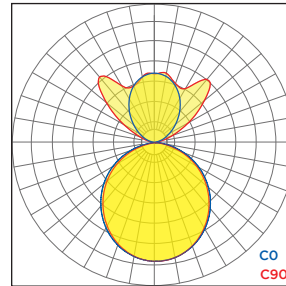

Batwing Indirect
Frosted Direct

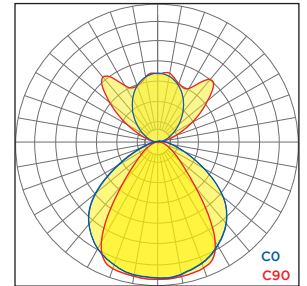



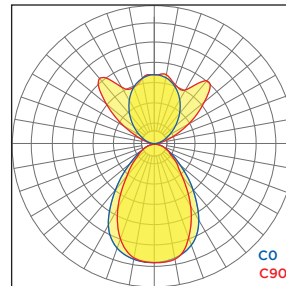



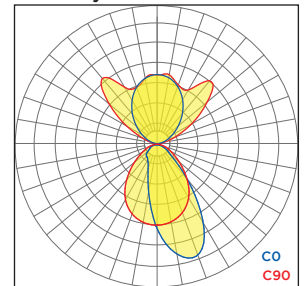

Batwing Indirect
Prismatic Direct



Batwing Indirect
Asymmetric Direct



CONTROL - DIM - EMERGENCY

Bluetooth 	Wireless 	Proximity 	Emergency 
DALI Dimming 	DSI Dimming 	Switch Dim 	Corridor Function 

CASAMBI

COLOURS

- Powder Coat Colours
- Dulux Protecture White (20T1274F)
 - Dulux Protecture Black (20T9215F)
 - Dulux Protecture Silver Pearl (Light Grey) (21T7852F)
 - Custom colours to order

5
YEAR

Lumatech Limited, 35 Timothy Place, Avondale,
Auckland, New Zealand.

Ph: 09-2813732 Email: sales@lumatech.co.nz www.lumatech.co.nz

LUMATECH

Linear Lighting Solutions

LUMEN/M

CRI90 p/m 4000K		150mA		200mA		250mA		300mA		350mA		400mA		Rows Direct Boards	Rows Indirect Boards	
		Lm	W	Lm	W	Lm	W	Lm	W	Lm	W	Lm	W			
LT60H Medium Output	Opal	Direct	1278	12.5	1703	16.7	2129	20.9	2555	25.0	2981	29.2	3407	33.4	1 x Medium Output	1 x Low Output
	Micro Prismatic		1308		1744		2180		2616		3052		3488			
	Frosted		1453		1937		2421		2906		3390		3874			
	Asymmetric Frosted		1503		2004		2505		3006		3507		4008			
	Batwing		Indirect		797		6.3		1063		8.3		1329			
Lumen output for other boards multiply lumens by		CRI90 3000K 0.96				CRI80 4000K 1.18				CRI80 3000K 1.13						
IES Files are standard for 1m. Specific length IES files are available on request. Example 4.7m.																

JOINS & CORNERS

Profile corners and joins are welded providing a seamless transitions and no light leakage.
 Custom angled joins on request.
 Joins can be horizontal or vertical

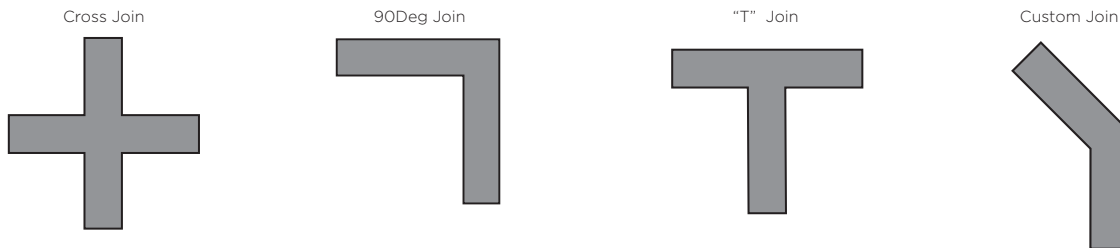

LENGTH CALCULATION

Luminaires are constructed by using combinations of geartray sizes starting at 565mm and up to 1685mm moving up in 70mm increments. This will give a fully illuminated diffuser from end to end and joins in the profile will be positioned by Lumatech to keep uniform lengths. High output and certain other specialist boards are only available in 280mm increments, please check with us if length is crucial. If a specific length is required in between LED board increments available, these are achieved using blanking plates. Endcap assemblies require a total of 15mm allowance, for recessed luminaires this becomes the cut-out dimension

ACCESSORIES & OPTIONS

- Screwed endcaps for budget applications.
- Screwless endcaps for a seamless look.
- Wall mount brackets or channel mount.

Lumatech Limited, 35 Timothy Place, Avondale,
 Auckland, New Zealand.

Ph: 09-2813732 Email: sales@lumatech.co.nz www.lumatech.co.nz